

1

4x18

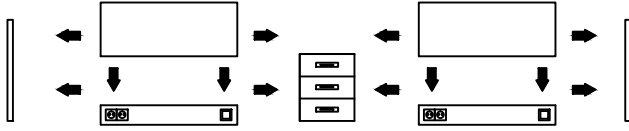

Modüllerin her birini kelebek bağlantı yardımı ile (4x18 lik)vida ile vidalayınız.

Worktop should be placed in the opposite way  
Screw the legs on the inverted tables with 4x18 screws.

2

4x18

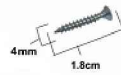

3.5x30

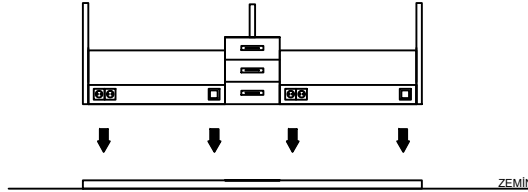
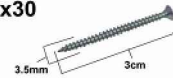

Bu aşamadan sonra ters çevrilmiş tablanın üzerine ayakları (4x18 lik )vida ile vidalayınız. Komodinleri üzerinde bulunan deliklerden (3,5x30 luk) vida ile tablaya montajını yapınız.

Mount the back panel of the unit and the footprint with 4x18 screws.

3

6x80

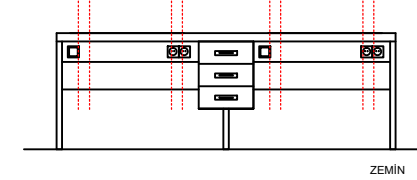

Tezgahı ters çevirip konumlandırınız. Arkalıktan duvara 6x80 vida ile montajını yapınız.

Put the unit in right position. Mount the backrest to the wall using 4x80 screws.

4

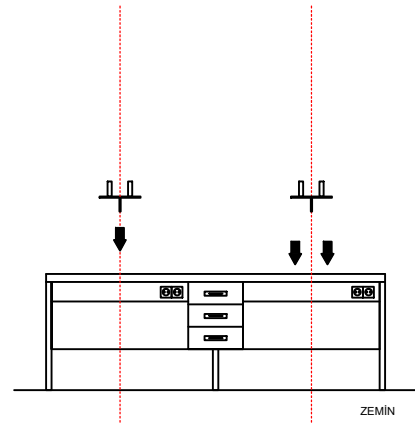

Metal aynaların ara aparatını müşterinin bulunduğu yere merkezleyip ara montaj aparatları tablaya somun ile sabitleyiniz.

Fix the mirrors by placing the center of the metal mirrors on the unite from 15 cm behind.

5

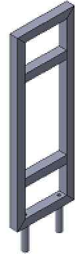

AYNA İÇİ MONTAJ ARAÇI

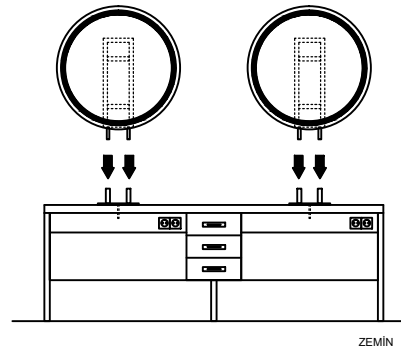

Ayna içi montaj aparatlarında bulunan çapı 25 mm boruyu, ara montaj aparatlarında bulunan çapı 21 mm boru ile iç içe geçiriniz.

Mount the unit through the pipes behind the mirrors.

6

MONTAJ SEMASI  
Assembly Instruction

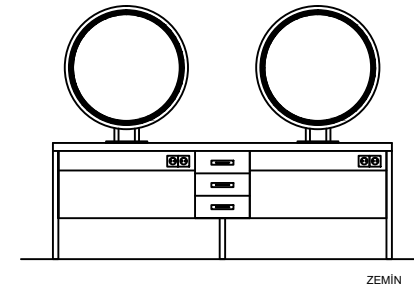

Tesisat bağlantılarını yapınız.

Make an electrical connections now.

ÜRÜN ADI:  
Name of product

CIRCLE ART

ÇİZEN:  
Designer:

DUYGU İLKHAN

TARİH:  
Date:

ÖLÇÜLER: cm (santimetre'dir)  
Çizim üstünden ölçü alınmalıdır.  
Measurements are in cm.