

1 4x18

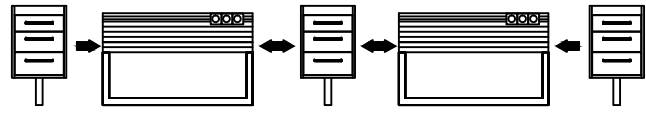
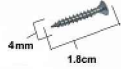

Kutulardan çıkartılan komodin ve alt gövde parçalarını 4x18 vida ile birleştiriniz.

Fix the cabinets to the lower part with 4x18 screws

2 6x80

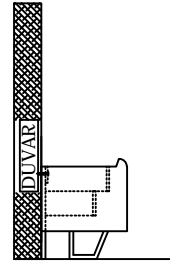

Birleştirilen alt ünite duvara 6x80 vida ile sabitleyiniz.

Mount the lower unit on the wall with 6x80 screws

3

MONTAJ SEMASI  
Assembly Instruction

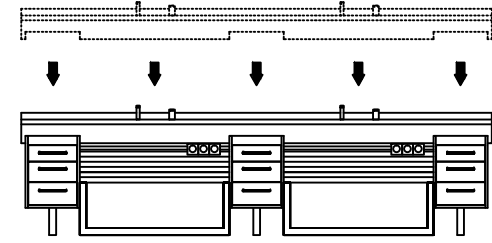

Corian tablanın ünite üstüne montajı yapılır.

The corian worktop is mounted on the counter.

4 6x80

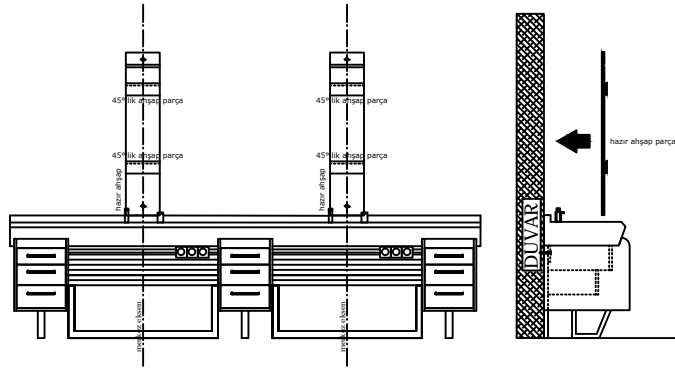

Gönderilen hazır ahşap parça merkez ekseninden hizalanarak 6x80 vida ile hazır ahşap parçaları duvara monte ediniz.

The ready-made wood is aligned with the center axis and 6x80 screws are mounted on the wall.

5 6x80

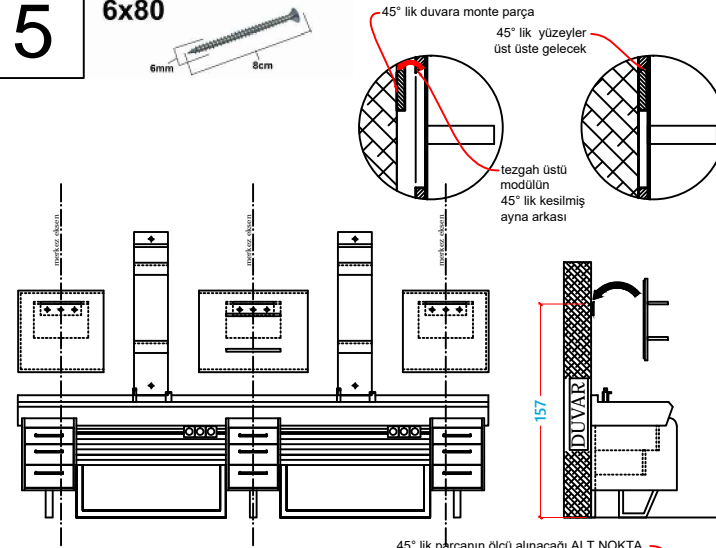

45° lik ahşap parçanın alt noktasından yükseklik ölçüsü alınmalıdır ki parça ile üst modül 45° lik yüzeyler üst üste otursun.

45 Degree angle from the bottom of the wooden piece should be taken from the height of the upper module at a 45-degree angle of the upper module

6

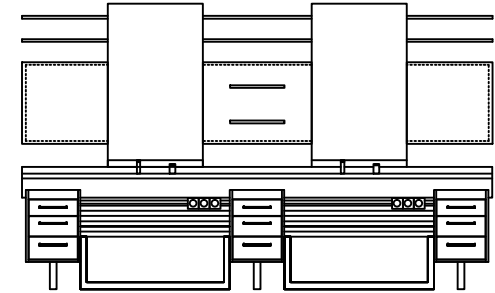

En son olarak ahşap dekor üstüne aynanın montajı ve tesisat bağlantılarını yapınız.

Make your plumbing connections now

ÜRÜN ADI:  
Name of product

ZEUS-RX MAN - ET006 K

ÇİZEN:  
Designer

DUYGU İLKHAN

TARİH  
Date:

ÖLÇÜLER: cm (santimetre'dir)  
Çizim üstünden ölçü alınmamalıdır.  
Measurements are in cm.